

USER MANUAL



LiFePO4 Battery 25.6V 200Ah

PRODUCT OVERVIEW >>>

Technical Standard : GB/T 36276-2018 or IEC62619

◆ BATTERY

25.6V 200Ah Deep Cycle Lithium Iron Phosphate Battery is designed for the drop-in replacement of deep-cycle lead-acid batteries with its standard Battery Council International (BCI) group size.

The battery adopts Class A high-quality cell, and the built-in BMS provides comprehensive protection for the battery.

Combination Support: **2S or 4P**

Dimension: **L520*W267*H217mm**

Plastic Shell Color: **Black**

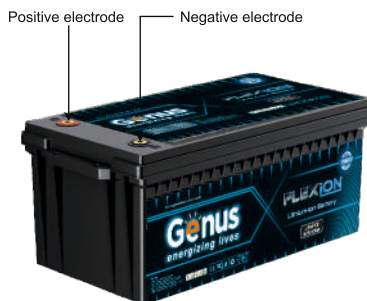

◆ TERMINAL & POST BOLTS

Terminal Size: **M8 *20mm Metric Thread**

8*14mm Bolt Length

(The bolts can be replaced with M8 bolts of other lengths based on actual needs.)

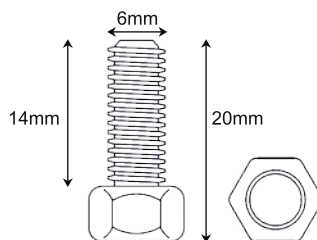

GENERAL INFORMATION

Operating Voltage: **25.6V**

Charging Voltage (max) : **29.0V±0.02V**

Max Continuous Load Power: **5120W**

Max Continuous Charge/Discharge Current: **200A**

CONTENTS

01	WHAT'S IN THE BOX?
01	Required Tools & Accessories
02	HOW TO SIZE BATTERY ADAPTER CABLES?
03	INSTALLATION AND USE
03	Plan a Mounting Site
	Step 1 Wear Insulating Gloves.
	Step 2 Remove the Dust Cover.
	Step 3 Check the Battery.
	Step 4 Run the Battery Adapter Cables Through the Insulating Sleeves.
	Step 5 Install Battery Terminals.
	Step 6 Install the Insulating Sleeves.
	Step 7 Connect the Battery to Other Devices.
07	SERIES OR PARALLEL BATTERY
	IN SERIES
	IN PARALLEL
08	Connecting batteries for correct current distribution
	OK
	NOT OK
09	Charging/Discharging Parameter Settings
03	Battery Charging and Discharging Logic
	Charging Logic
	Discharging Logic
09	How to Estimate the Battery SOC?
11	BATTERY MANAGEMENT SYSTEM
03	Troubleshooting
03	Specifications
03	Maintenance & Storage
14	IMPORTANT SAFETY INSTRUCTIONS
15	BLUETOOTH CONNECTION
16	ATTENTION

WHAT'S IN THE BOX? >>>

25.6V 200Ah Deep Cycle
Lithium Iron Phosphate Battery × 1



User Manual × 1



Insulating Sleeve × 2



Long Terminal Bolt × 2

Make sure that all accessories are complete and free of any signs of damage.

Required Tools & Accessories



Torque wrench



M8

Battery Adapter Cables × 2



Insulating Gloves



Multimeter

Prior to installing and configuring the battery, prepare the recommended tools, components, and accessories.

For how to size battery adapter cables, refer to "How to Size Battery Adapter Cables?" in this manual.

HOW TO SIZE BATTERY ADAPTER CABLES? >>>

Use appropriately sized Battery Adapter Cables (sold separately) based on expected load. Refer to the table below for copper cable ampacities with different gauge sizes.

Cable Gauge Size	Ampacity	Cable Gauge Size	Ampacity
14 AWG (2.08 mm ²)	35A	2 AWG (33.6 mm ²)	190A
12 AWG (3.31 mm ²)	40A	1 AWG (42.4 mm ²)	220A
10 AWG (5.25 mm ²)	55A	1/0 AWG (53.5 mm ²)	260A
8 AWG (8.36 mm ²)	80A	2/0 AWG (67.4 mm ²)	300A
6 AWG (13.3 mm ²)	105A	4/0 AWG (107 mm ²)	405A
4 AWG (21.1 mm ²)	140A		



The above values are from the NEC Table 310.17 for copper cables rated at 194°F (90°C), operating at an ambient temperature of no more than 86°F (30°C). Cables longer than 13 feet (4000 mm) may



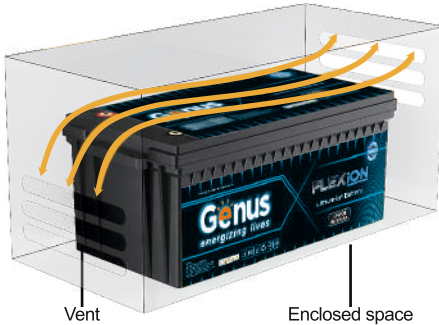

◆ Plan a Mounting Site

For optimal battery performance, it is recommended to install the battery in a clean, cool, and dry location, free from any accumulation of water, oil, or dirt. Accumulation of such materials on the battery can lead to current leakage, self-discharge, and even short-circuiting.



 Charge: 32°F–131°F / 0°C–55°C
Discharge: -4°F–140°F / -20°C–60°C
 10%–95%

 Sufficient air flow must be provided to prevent excessive heat build-up and to minimize temperature variation between the connected batteries.

 This user manual takes a battery as an example to illustrate how to install the battery.

Step 1 Wear Insulating Gloves



Insulating Gloves



Step 2 Remove the Dust Cover.



Step 3 Check the Battery

Inspect the battery for any visible damage including cracks, dents, deformation, and other visible abnormalities. All connector contacts shall be clean, free of dirt and corrosion, and dry.



Do not touch the exposed electrolyte or powder if the battery is damaged.





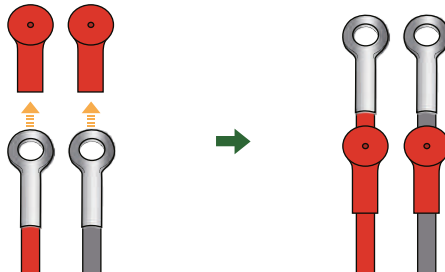

If uncovered electrolyte or powder contacts your skin or eyes, flush it out immediately with plenty of clean water and seek medical attention.

Step 4 Run the Battery Adapter Cables Through the Insulating Sleeves.

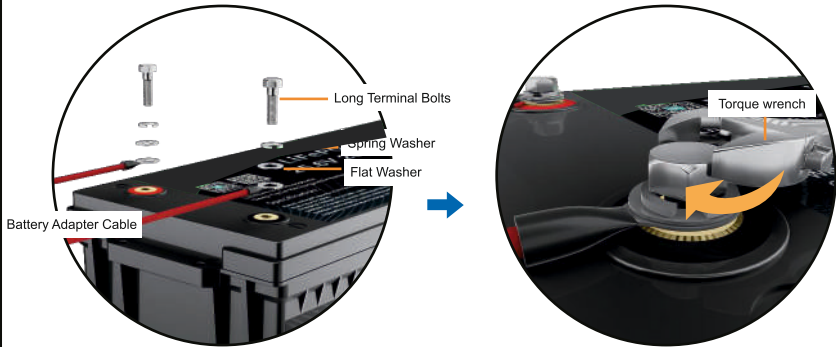

Step 5 Install Battery Terminals



-  Ensure the cable lug and the top surface of the terminal are in contact, and place the washers on top of the lug. Do not place the washers between the battery terminal and the cable lug to avoid high resistance and excessive heating.
-  Avoid short-circuiting the battery terminals to prevent irreversible damage to the system and battery caused by current bursts.
-  Verify polarity before wiring to avoid irreversible battery damage due to polarity reversal.
-  To ensure safe and reliable operation of the system, please follow the manufacturer's recommended torque specifications when securing cable connections. Over-tightening can result in terminal breakage, while loose connections can lead to terminal meltdown or fire. When securing multiple cable lugs on a single battery terminal, use the included Long Terminal Bolts.

Step 6 Install the Insulating Sleeves.

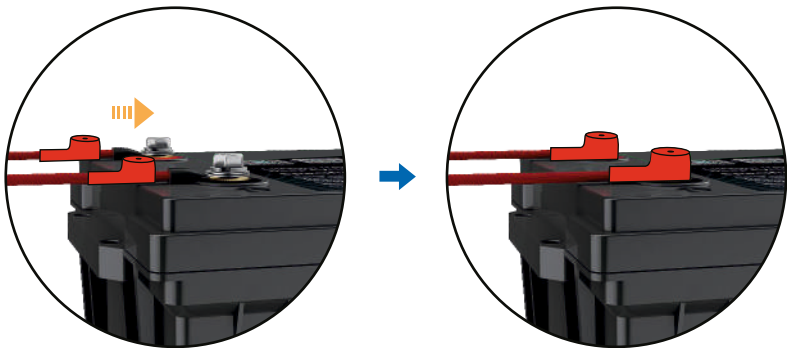

Step 7 Connect the Battery to Other Devices



Please use circuit breakers, fuses, or disconnects appropriately sized by a certified electrician, licensed installers, or regional code authorities to protect all electrical equipment.

◆ For a Single Battery

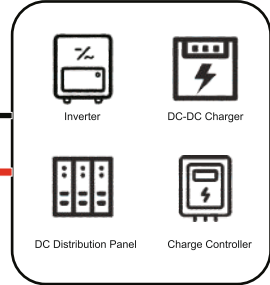

◆ For Batteries in Parallel

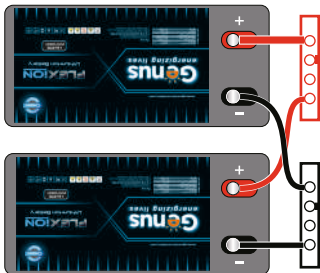

Battery Fuse

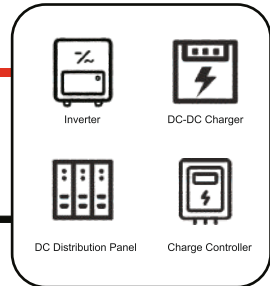

◆ For Batteries in Series

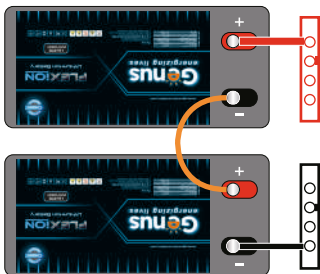

Battery Fuse

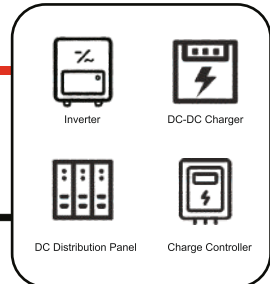

SERIES OR PARALLEL BATTERY



The max. number of batteries in parallel is 4pcs and the max. number of batteries in series is 2pcs. To divide the current equally amongst batteries, use the schematic below:

◆ IN PARALLEL

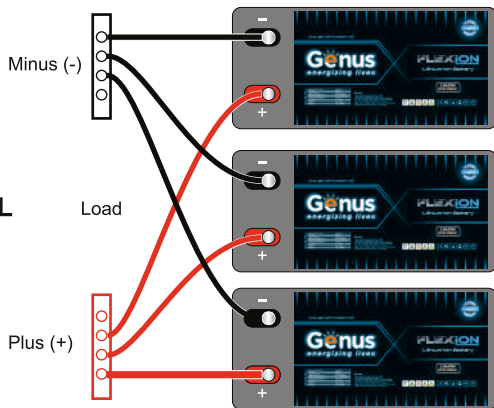

◆ IN SERIES

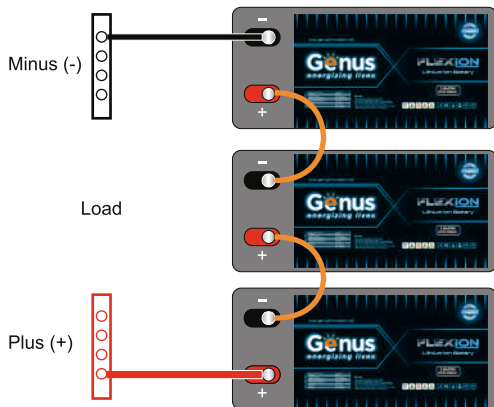

Connecting batteries for correct current distribution

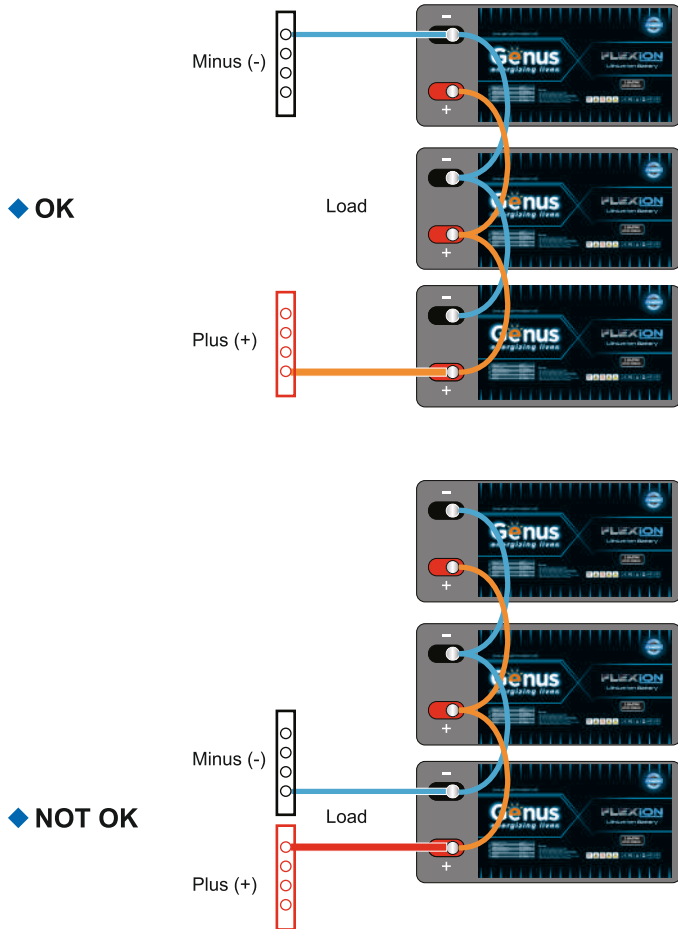

OK: Equally divided battery current. All batteries contribute equally to the current into the load.

NOT OK: Current not equally divided.

Batteries closest to load will have the highest contribution to the current into the load. Whereas batteries further away from load will have lesser current contribution.

Wear and tear will be higher on LiFePO₄ battery close to the load.

Charging/Discharging Parameter Settings

◆ Charge

Charge/Boost Voltage	14.4V	Boost Return Voltage	13.2V
Bulk/Absorption Voltage	14.4V	Overvoltage Disconnect	15.0V
Bulk/Absorption Voltage	14.4V / Disabled	Overvoltage Reconnect	14.2V

◆ Discharge

Low Voltage Reconnect	12.6V	Undervoltage Warning	12.0V
Undervoltage Shutdown	10.0V	Overvoltage Disconnect	

 The parameters in the table are applicable to 12V (12.8V) battery packs. Please multiply by 2 for 24V (25.6V) packs and multiply by 4 for 48V (51.2V) packs.

Battery Charging and Discharging Logic

The battery may be received at a partial state of charge (SOC) depending on the time between manufacturing and shipping. It is crucial to fully charge the battery before its initial use. In case the battery shuts off due to low SOC, promptly disconnect it from loads and charge it to prevent irreversible damage. Follow the instructions in this user manual for proper charging and usage to ensure optimal battery performance and longevity.

◆ Charging Logic

The standard charging process for the battery involves charging at a constant current of 100A until the battery voltage reaches 14.4V, followed by charging at a constant voltage of 14.4V while tapering the charge current. The charging process is considered complete when the charge current is less than 10A (also known as tail current).

The standard charging process typically takes 2.5 hours and requires battery temperatures to be between 32°F and 131°F (0°C and 55°C) for safe charging. Leaving the battery on float will continue to balance the battery cells without damaging the battery.

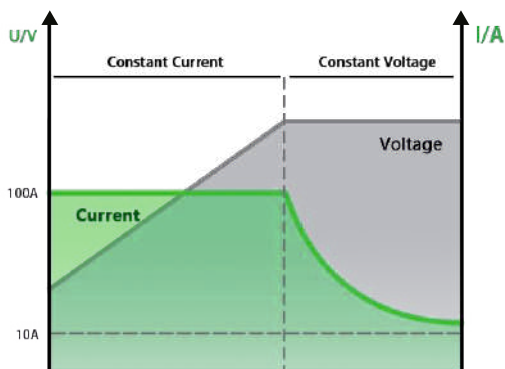

 Lithium batteries are compatible with various charging methods, including MPPT charge controller, AC charger, and DC-DC charger. The crucial parameter setting for these chargers is to set the charge voltage, boost voltage, or bulk voltage at 29.0V ($\pm 0.2V$).

 Do not overcharge or overdischarge the battery.

 Do not charge the battery at low temperatures below 32°F (0°C) and discharge the battery at high temperatures above 140°F (60°C).

 Only charge the battery with a battery charger or charge controller that is compatible with lithium iron phosphate batteries.

 Do not exceed the maximum continuous charge current (200A) of the battery.

◆ Discharging Logic

During standard discharging, the battery is discharged at a constant current of 100A until the voltage drops to 10V. To ensure safe discharging, the battery temperature should be between -4°F (-20°C) and 131°F (60°C).

 To ensure safe and optimal battery usage, it is recommended to pair the battery with discharge equipment that features a low voltage disconnect (LVD) function.

 Do not connect large loads to the battery when it is running low.

 Do not exceed the maximum continuous discharge current (200A) of the battery.

How to Estimate the Battery SOC?

The SOC values listed below are estimated based on the resting voltage when the battery is at rest for 30 minutes, not in charging or discharging state.

SOC	Charge Voltage	SOC	Charge Voltage
100%	27.2V	30%	25.8V
99%	26.8V	20%	25.6V
90%	26.4V	14%	25.4V
70%	26.2V	9%	25.6V
40%	26.0V	0%	10.0V

 The table above is for reference only because slight variations in battery voltage may occur among different batteries.

BATTERY MANAGEMENT SYSTEM



The battery is equipped with a Battery Management System (BMS) that provides warnings and protections against overvoltage, undervoltage, overcurrent, short circuit, high temperature, and low temperature conditions. Refer to the table below for the triggering and recovery conditions of each warning and protection.

Battery Operating Status		Condition (For Reference Only)	
Battery Cell Overvoltage	Protection	Trigger	Battery Cell Voltage $\geq 3.65V$
		Recover	Battery Cell Voltage $\leq 3.45V$ /Discharge current $\geq 1A$
Battery Cell Undervoltage	Protection	Trigger	Battery Cell Voltage $\leq 2.5V$
		Recover	Battery Voltage $\geq 2.8V$
Charge High Temperature	Protection	Trigger	Battery Temperature $\geq 131^{\circ}F (55^{\circ}C)$
		Recover	Battery Temperature $\leq 113^{\circ}F (45^{\circ}C)$
Discharge High Temperature	Protection	Trigger	Battery Temperature $\geq 140^{\circ}F (60^{\circ}C)$
		Recover	Battery Temperature $\leq 122^{\circ}F (50^{\circ}C)$
Charge Low Temperature	Protection	Trigger	Battery Temperature $\leq 32^{\circ}F (0^{\circ}C)$
		Recover	Battery Temperature $\geq 41^{\circ}F (5^{\circ}C)$
Charge Overcurrent	Protection	Trigger	Charge Current $\geq 220A$ (Delay 15s)
		Recover	(Delay 1min)
Discharge Overcurrent	Protection	Trigger	Discharge Current $\geq 220A$
		Recover	(Delay 1min)
Short Circuit	Protection	Trigger	Discharge Current $\geq 1000A$
		Recover	Remove Short Circuit(300 μ s)

Troubleshooting

Problem	Possible Causes	Solution
<ul style="list-style-type: none"> • The battery is unable to be activated with a charge/discharge current greater than 1A • The battery is activated at resting voltage below 20V 	Severe battery overdischarge due to self-discharge or parasitic loads	Revive the battery with a battery charger or charge controller featuring lithium battery activation or force charging.

Problem	Possible Causes	Solution
The battery shuts off due to undervoltage protection.	The battery voltage drops below the preset threshold	Disconnect the battery from loads, and charge the battery with a current greater than 1A as soon as possible.
The battery cuts off the charging current due to overvoltage protection	The battery voltage exceeds the preset threshold during charging.	<ol style="list-style-type: none"> 1. Disconnect the battery from the charging source. 2. Reduce charge voltage by 0.2V to 0.4V for 6 hours. 3. Attempt to fully charge the battery again with the correct voltage setting. If the problem persists with a lithium iron phosphate compatible charging source and correct voltage setting, repeat the above steps.
The battery temperature gets too high/low during operation and triggers high/low temperature protection	The battery temperature exceeds the preset threshold.	<ol style="list-style-type: none"> 1. Disconnect the battery from the charging source or loads. 2. Cool down/Warm up the battery. 3. The battery recovers from high/low temperature protection automatically and continues operating.
The battery is shorted and triggers short circuit protection.	Short circuit occurs in the battery.	<ol style="list-style-type: none"> 1. Remove the short circuit as soon as possible 2. Charge the battery with a current greater than 1A.
Charge/Discharge over-current protection is triggered due to too high current passing through the battery.	Excessive current flows through the battery during charging or discharging.	Disconnect the battery from the charging source or loads as soon as possible.

Specifications

◆ General

Battery Cell Type	Lithium Iron Phosphate
Rated Capacity (0.5C, 25°C)	200Ah
Nominal Voltage	25.6V
Voltage Range	20V to 24.2V
Cycle Life (0.5C, 25°C)	6000 Cycles (80% DOD)
Dimension	20.47 x 10.51 x 8.54 in / 520 x 267 x 217 mm
Weight	57 lbs / 36kg
Connection Method	Series & Parallel (2S4P)
Terminal Bolt Size	M6 x 8 x 14 mm
Recommended Terminal Torque	88.5 inch-lbs to 106.2 inch-lbs / 10 N-m to 12 N-m
Protection Rating	IP65
Certification	MSDS, UN38.3, FCC, CE, IEC, PSE

◆ Operation Parameters

Charge Voltage	25.6V
Maximum Continuous Charge Current	200A
Maximum Continuous Discharge Current	200A
Peak Discharge Current	400A@3s
Charge Temperature Range	32°F to 131°F (0°C to 55°C)
Discharge Temperature Range	-4°F to 140°F (-20°C to 60°C)
Storage Temperature Range	-13°F to 149°F (-25°C to 65°C)
Operation Relative Humidity	10% to 95%

Maintenance & Storage

◆ Inspection

Please perform regular inspections following the steps below:

- Examine the external appearance of the battery. The housing and terminals of the battery shall be clean, dry, and free of corrosion.
- Check battery cables and connections. Replace any damaged cables and tighten any loose connections.
- ⓘ In certain application scenarios, corrosion may occur around the terminals. Corrosion can cause increased resistance and poor contact. It is recommended to regularly apply insulation grease to each terminal. Insulation grease can form a moisture-resistant seal and protect the terminals from corrosion.

◆ Cleaning

Please clean the battery at regular intervals following the steps below:

- Disconnect the battery from the system.
- Clear the leaves and debris from the battery.
- Clean the battery with a soft, lint-free cloth. The cloth can be dampened with water or mild soap and water if the battery is extremely dirty.
- Dry the battery with a soft, lint-free cloth.
- Keep the area around the battery clean.
- Reconnect the battery to the system.

◆ Checking Voltage

Please check the battery voltage periodically to assess battery health. If the battery is unable to be activated with a charge/discharge current greater than 1A or the battery is activated with a resting voltage below 10V, the battery may have been severely overdischarged due to self-discharge or parasitic loads. Please stop using the battery until the fault can be corrected and the battery can be charged.

◆ Storage

Please follow the tips below to ensure that the battery emerges from storage in a good condition:

- Charge the battery to 30% to 50% SOC.
- Disconnect the battery from the system.
- Store the battery in a well-ventilated, dry, clean area with temperatures between -13°F (-25°C) and 149°F(65°C).
- Do not expose the battery to direct sunlight, moisture, or precipitation.
- Handle the battery carefully to avoid sharp impacts or extreme pressure on the battery housing.
- Charge the battery at least once every 3 to 6 months to prevent it from overdischarge.
- Fully charge the battery when it is taken out of storage.

IMPORTANT SAFETY INSTRUCTIONS



The manufacturer accepts no liability for any damage caused by:

- Force majeure including fire, typhoon, flood, earthquake, war, and terrorism.
- Intentional or accidental misuse, abuse, neglect or improper maintenance, and use under abnormal conditions.
- Improper installation, improper operation, and malfunction of a peripheral device.
- Contamination with hazardous substances or radiation.
- Alterations to the product without express written consent from the manufacturer.

◆ General

- Wear proper protective equipment and use insulated tools during installation and operation. Do not wear jewelry or other metal objects when working on or around the battery.
- Keep the battery out of the reach of children.
- Do not dispose of the battery as household waste. Comply with local, state, and federal laws and regulations and use recycling channels as required.
- In case of fire, put out the fire with a FM-200 or CO2 fire extinguisher.
- Do not expose the battery to flammable or harsh chemicals or vapors.
- Clean the battery regularly.
- It is recommended that all cables should not exceed 10 meters because excessively long cables result in a voltage drop.
- The cable specifications listed in the quick guide account for critical, less than 3% voltage drop and may not account for all configurations.
- Do not expose the battery to strong electrostatic fields, strong magnetic fields, or radiation.

◆ Battery Safety

- Please keep the battery away from water, heat sources, sparks, and hazardous chemicals.
- Do not puncture, drop, crush, burn, penetrate, shake, strike, or step on the battery.
- Do not open, dismantle, repair, tamper with, or modify the battery.
- Do not touch any terminals or connectors.
- Please make sure any battery charger or charge controller has been disconnected before working on the battery.
- Do not connect or disconnect terminals from the battery without first disconnecting loads.
- Do not place tools on top of the battery.
- Please use suitable handling equipment for safe transportation of the battery.
- Do not insert foreign objects into the positive and negative terminals of the battery.

BLUETOOTH CONNECTION



Scan the QR code on the side of the battery or the QR code in the user manual with the mobile phone, download and install the App, turn on the Bluetooth and enter the App, connect the battery through Bluetooth, and you can check the battery data

➤ Currently it only supports Android phones

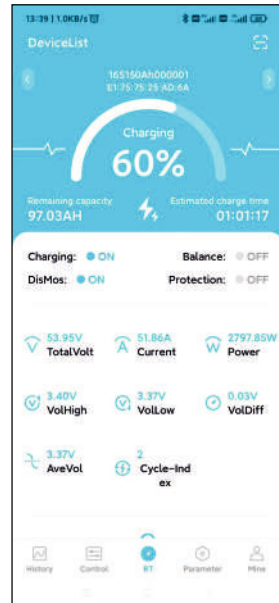

ATTENTION



CAUTION: RISK OF FIRE, EXPLOSION OR BURNS

DO NOT Short circuit

DO NOT Heat above 70°C

DO NOT Reverse connections from charger to battery

DO NOT Disassemble

DO NOT Throw into fire or incinerate

WARNING

BATTERY DISPOSAL

The electrodes of the waste battery should be wrapped with insulating paper to prevent fire and explosion.

PROHIBITION OF DISASSEMBLY

Never disassemble the cells.

The disassembling may generate an internal short circuit in the cell, which may cause gassing, firing, explosion, or other problems.

The electrolyte is harmful.

Li-Fe battery should not have liquid from electrolyte flowing, but in case the electrolyte comes into contact with the skin, or eyes, physicians shall slush the electrolyte immediately with fresh water and medical advice is to be sought.

PROHIBITION OF DUMPING OF CELLS INTO WATER

Do not soak the battery in which the liquid, like water, seawater and non-alcoholic drinks, fruit juice, coffee or other drinks.

PROHIBITION OF USE OF DAMAGED CELLS

If any abnormal features of the cells are found such as damages in a plastic envelope of the cell, deformation of the cell package, smelling of an electrolyte, an electrolyte leakage and others, the cells shall never be used anymore. The cells with a smell of the electrolyte or a leakage shall be placed away from the fire to avoid firing or explosion.

PROHIBITION OF USING IN BELOW PLACES

Do not use the battery in a place with strong static electricity and a strong magnetic field, otherwise, it is easy to damage the battery safety protection device and bring hidden danger.